

LAJA

E62026 – MINI MONO BASIN MIXER

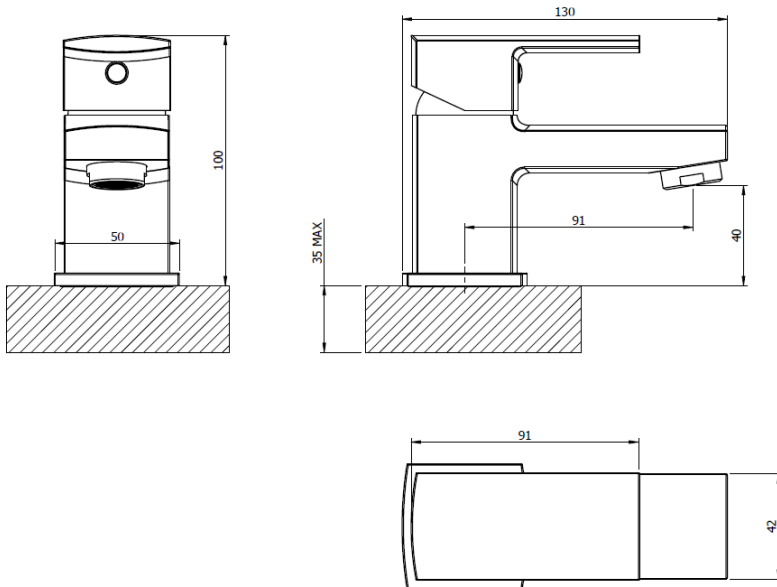

Specification

Finish	Black
Body	Brass
Fittings	Metal plate, washer, stud & locking nut
Connection	M12 - DN8 Flexible hoses - 1/2" BSP thread ends
Min dynamic pressure	0.1
Max dynamic pressure	6
Max static pressure	16
Max water temperature	60°C

Flow rates

Pressure	0.1	0.5	1	3
Aerator	1.5	2.2	3.4	3.5
F/Straight	2.7	8.4	12.4	22.0

All Pressures in Bar. All flow in L/Min.
 Dimensions supplied are nominal and subject to tolerance.
 Inclusion or restrictors (sold separately unless stated) will affect flow rate result.
 Performance details are based on trials under test conditions and for guidance only.
 The Company reserves the right to change product specification without prior notice.

Features & Benefits

10 YEAR Guarantee	Low Pressure	Flexible Hose	Click Waste
Flow Straightener	Eco Aerator	Single Flow	

Certifications

5.0 l/min	
Tested @ 0.2 bar	



LAJA

E62027 – MONO BASIN MIXER

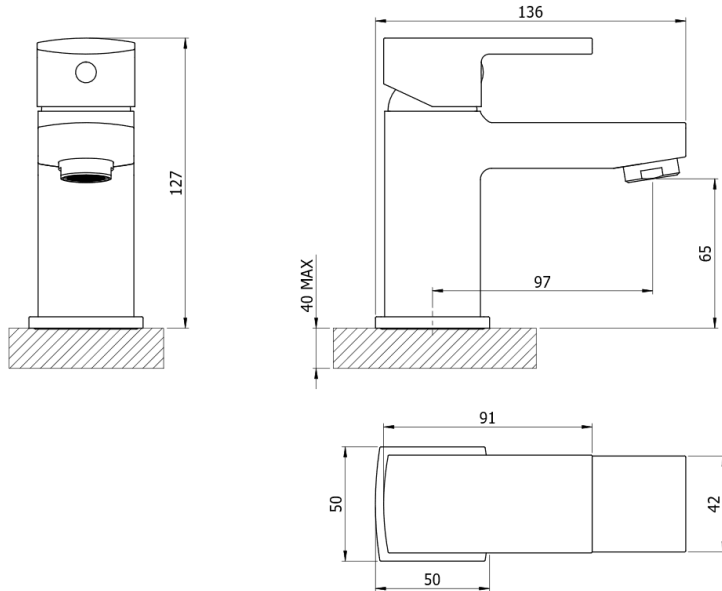

Specification







Finish	Black
Body	Brass
Fittings	Metal plate, washer, stud & locking nut
Connection	M12 - DN8 Flexible hoses - 1/2" BSP thread ends
Min dynamic pressure	0.1
Max dynamic pressure	6
Max static pressure	16
Max water temperature	60°C

Flow rates

Pressure	0.1	0.5	1	3
Aerator	1.5	2.2	3.4	3.5
F/Straight	2.7	8.4	12.4	22.0

All Pressures in Bar. All flow in L/Min.
 Dimensions supplied are nominal and subject to tolerance.
 Inclusion or restrictors (sold separately unless stated) will affect flow rate result.
 Performance details are based on trials under test conditions and for guidance only.
 The Company reserves the right to change product specification without prior notice.

Features & Benefits

 Guarantee	 Low Pressure	 Flexible Hose	 Click Waste
 Flow Straightener	 Eco Aerator	 Single Flow	

Certifications

	
Tested @ 0.2 bar	







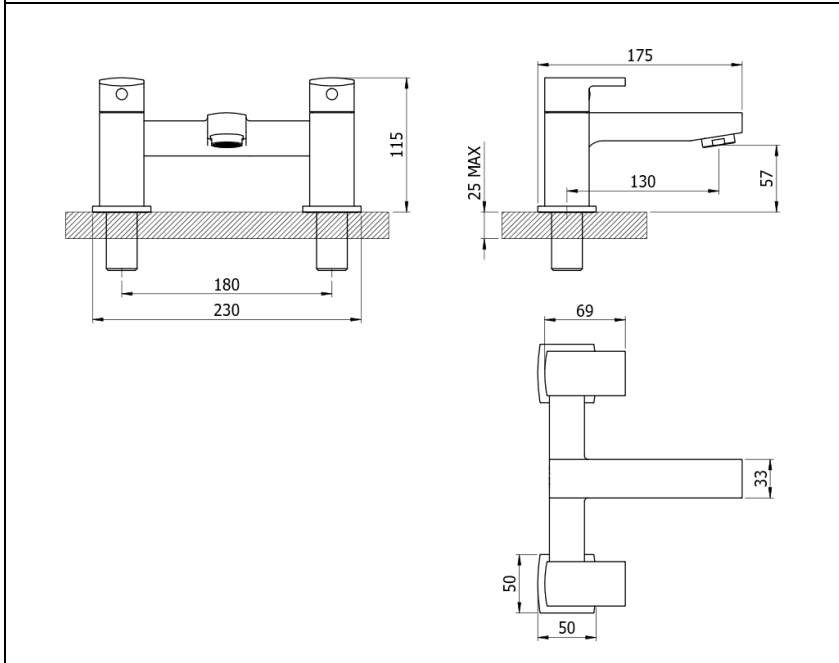

www.esteembathrooms.com

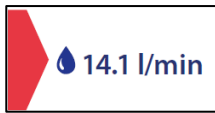
LAJA

E62028 – BATH FILLER



Specification				
Finish	Matt Black			
Body	Brass			
Fittings	Brass backnut & washer			
Connection	3/4" BSP Threaded tail			
Min dynamic pressure		0.1		
Max dynamic pressure		6		
Max static pressure		25		
Max water temperature		60°C		
Flow rates				
Pressure	0.1	0.5	1	3
Aerator				
F/Straight	7.3	23.8	34.4	61.4
<p>All Pressures in Bar. All flow in L/Min. Dimensions supplied are nominal and subject to tolerance. Inclusion or restrictors (sold separately unless stated) will affect flow rate result. Performance details are based on trials under test conditions and for guidance only. The Company reserves the right to change product specification without prior notice.</p>				
Certifications				
				
Tested @ 0.2bar				

Features & Benefits			
 10 YEAR Guarantee	 L Low Pressure	 Brass Backnut	 Flow Straightener
 Flow Aerator	 Single Flow		



LAJA

E62029 – BATH & SHOWER MIXER

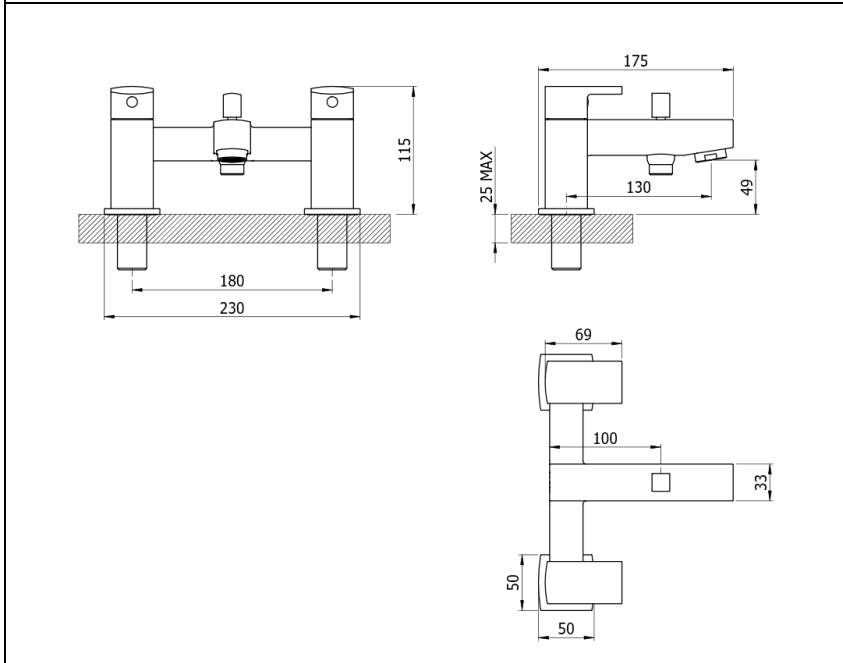

Specification

Finish	Matt Black
Body	Brass
Fittings	Brass backnut & washer
Connection	3/4" BSP Threaded tail
Min dynamic pressure	0.1
Max dynamic pressure	6
Max static pressure	25
Max water temperature	60°C

Flow rates

Pressure	0.1	0.5	1	3
Aerator				
F/Straight	7.3	23.8	34.4	61.4

All Pressures in Bar. All flow in L/Min.
 Dimensions supplied are nominal and subject to tolerance.
 Inclusion or restrictors (sold separately unless stated) will affect flow rate result.
 Performance details are based on trials under test conditions and for guidance only.
 The Company reserves the right to change product specification without prior notice.

Features & Benefits

10 YEAR Guarantee	Low Pressure	Brass Backnut	Flow Straightener
Flow Aerator	Shower Kit Included	Single Flow	

Certifications

14.1 l/min	
Tested @ 0.2bar	



www.esteembathrooms.com

LAJA

E62030 – MINI MONO BASIN MIXER

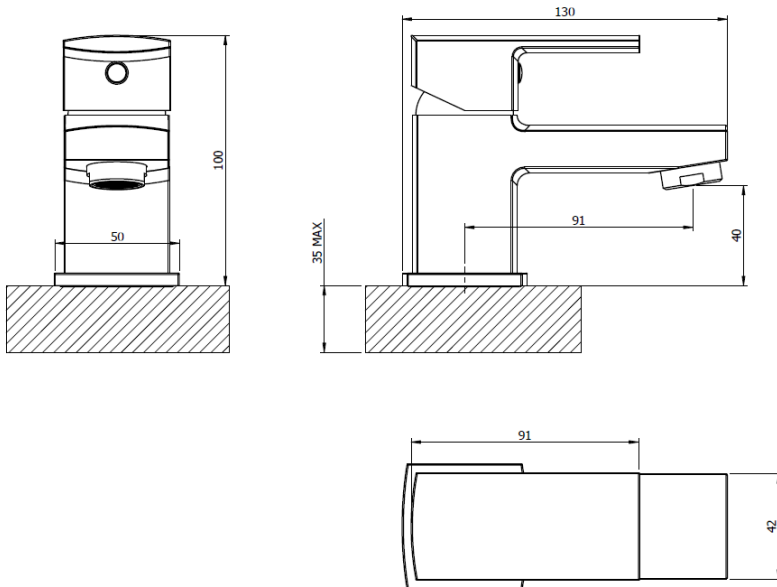

Specification

Finish	Chrome
Body	Brass
Fittings	Metal plate, washer, stud & locking nut
Connection	M12 - DN8 Flexible hoses - 1/2" BSP thread ends
Min dynamic pressure	0.1
Max dynamic pressure	6
Max static pressure	16
Max water temperature	60°C

Flow rates

Pressure	0.1	0.5	1	3
Aerator	1.5	2.2	3.4	3.5
F/Straight	2.7	8.4	12.4	22.0

All Pressures in Bar. All flow in L/Min.
 Dimensions supplied are nominal and subject to tolerance.
 Inclusion or restrictors (sold separately unless stated) will affect flow rate result.
 Performance details are based on trials under test conditions and for guidance only.
 The Company reserves the right to change product specification without prior notice.

Features & Benefits

10 YEAR Guarantee	Low Pressure	Flexible Hose	Click Waste
Flow Straightener	Eco Aerator	Single Flow	

Certifications

5.0 l/min	
Tested @ 0.2 bar	



LAJA

E62031 – MONO BIDET MIXER

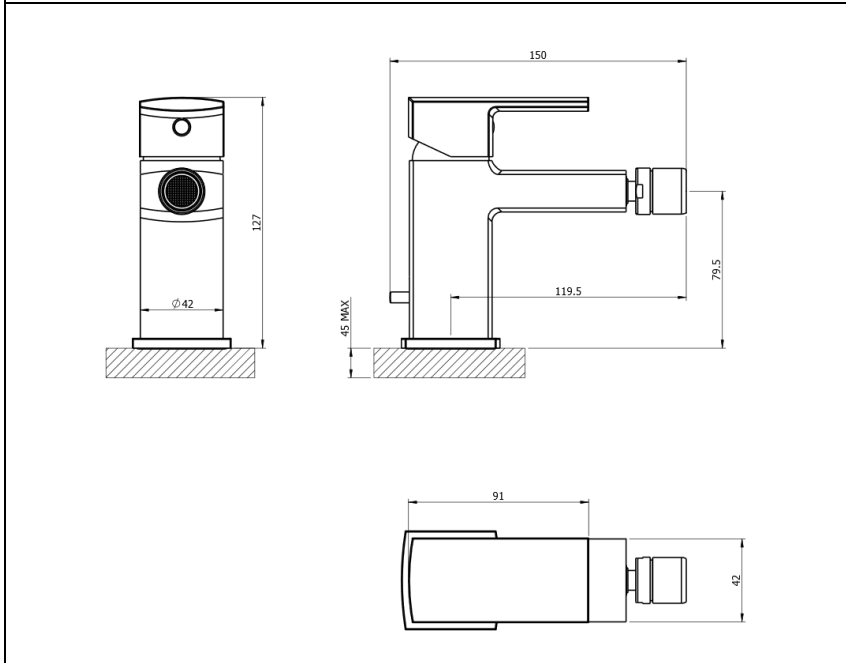

Specification







Finish	Chrome
Body	Brass
Fittings	Metal plate, washer, stud & locking nut
Connection	M12 - DN8 Flexible hoses - 1/2" BSP thread ends
Min dynamic pressure	0.5
Max dynamic pressure	6
Max static pressure	16
Max water temperature	60°C

Flow rates

Pressure	0.1	0.5	1	3
Aerator	1.4	4.2	5.9	7.6
F/Straight				

All Pressures in Bar. All flow in L/Min.
 Dimensions supplied are nominal and subject to tolerance.
 Inclusion or restrictors (sold separately unless stated) will affect flow rate result.
 Performance details are based on trials under test conditions and for guidance only.
 The Company reserves the right to change product specification without prior notice.

Features & Benefits

 Guarantee	 Medium Pressure	 Flexible Hose	 Pop-Up Waste
 Flow Aerator	 Single Flow		

Certifications

	
Tested @ 0.5 bar	



www.esteembathrooms.com